

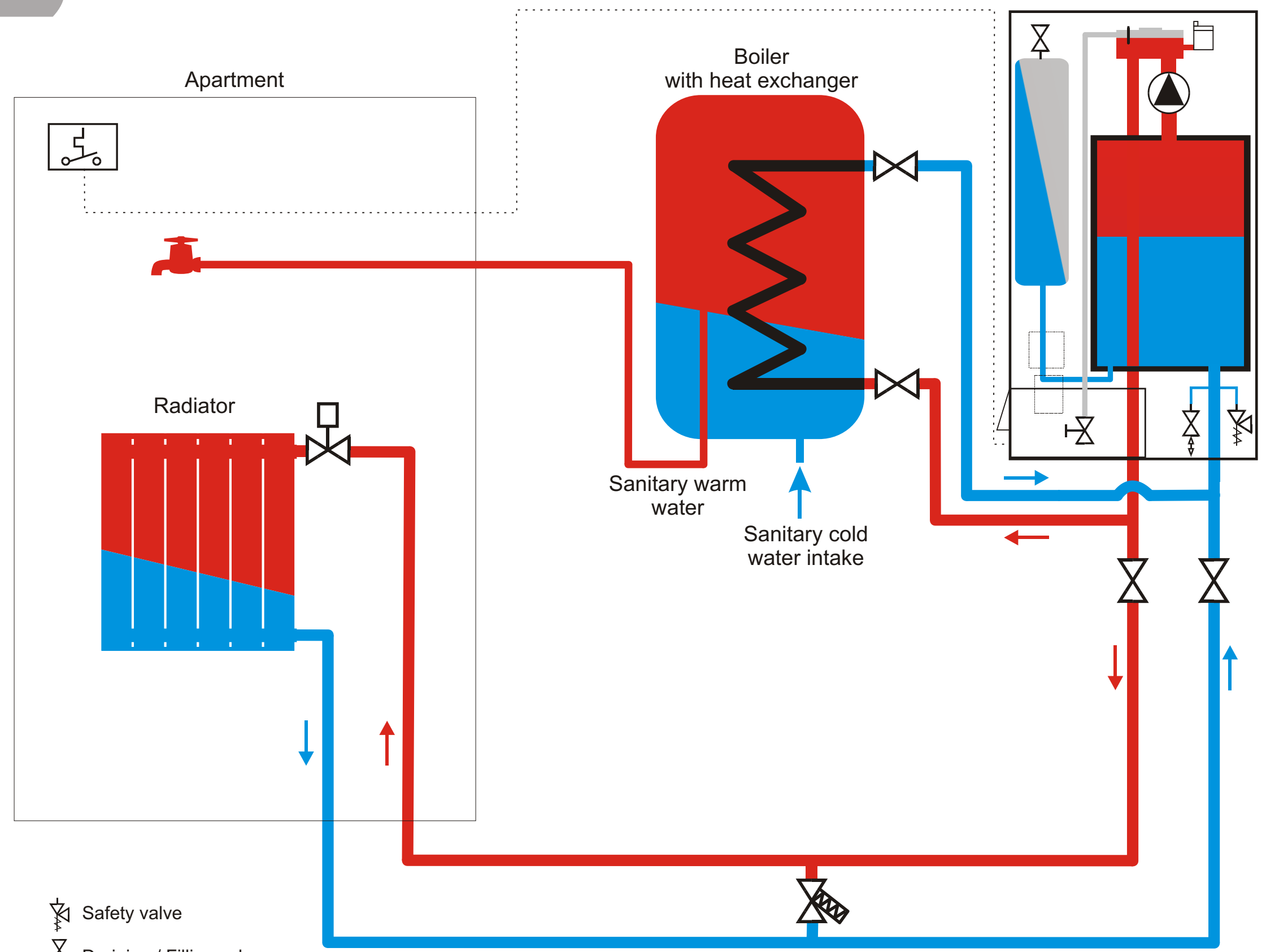

Complete



### Legend

- Pump
- Valve
- Thermal valve
- Overflow valve
- Ambient thermostat
- Automatic vent slide
- Safety valve
- Draining / Filling valve
- Temperature sensor
- One way valve
- Air venting valve

**Remark:**  
This schema is for informational purposes only, not all details necessary for deployment are shown.  
**DO NOT USE THIS SCHEMA AS DEPLOYMENT PLAN.**



Industrial

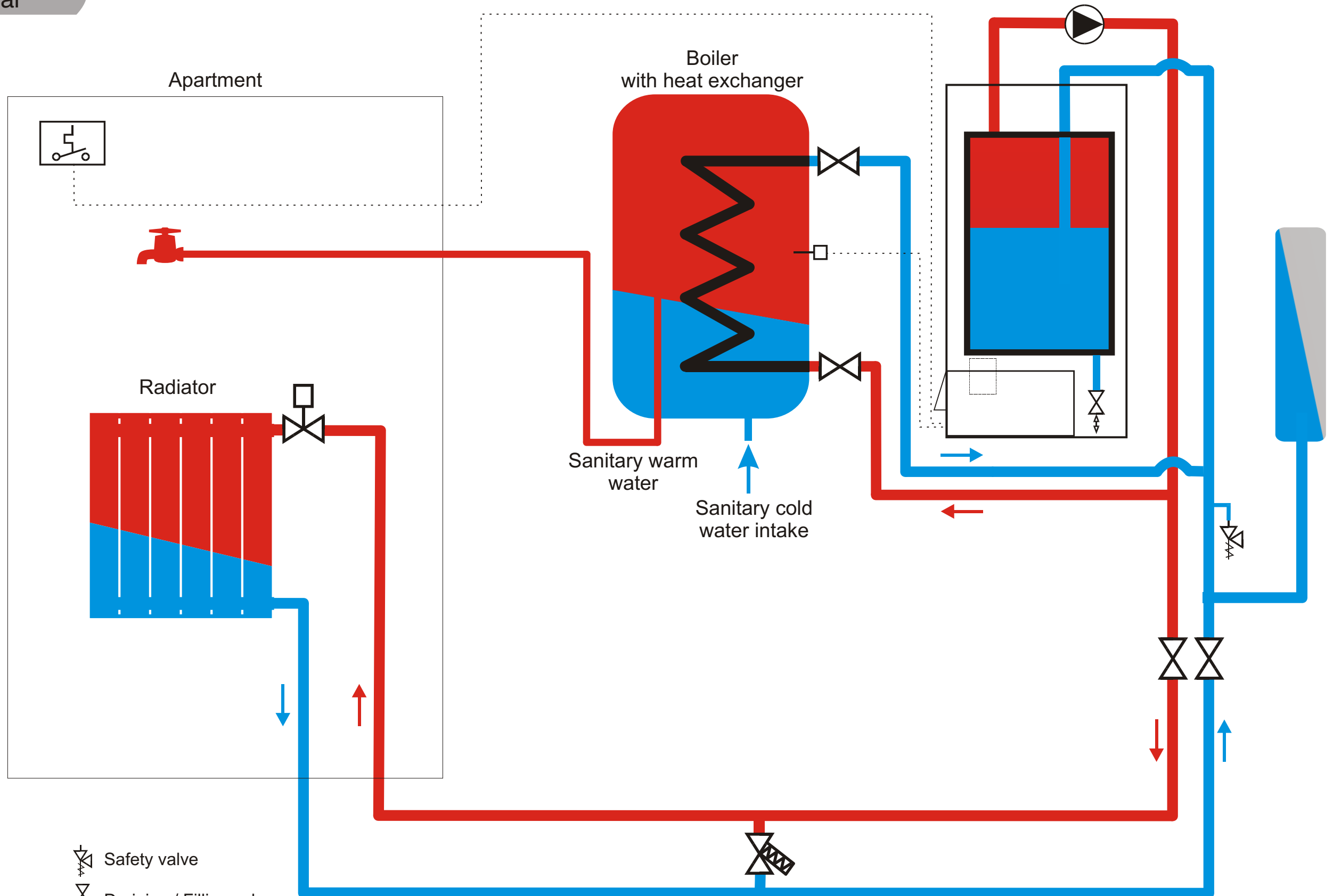

### Legend







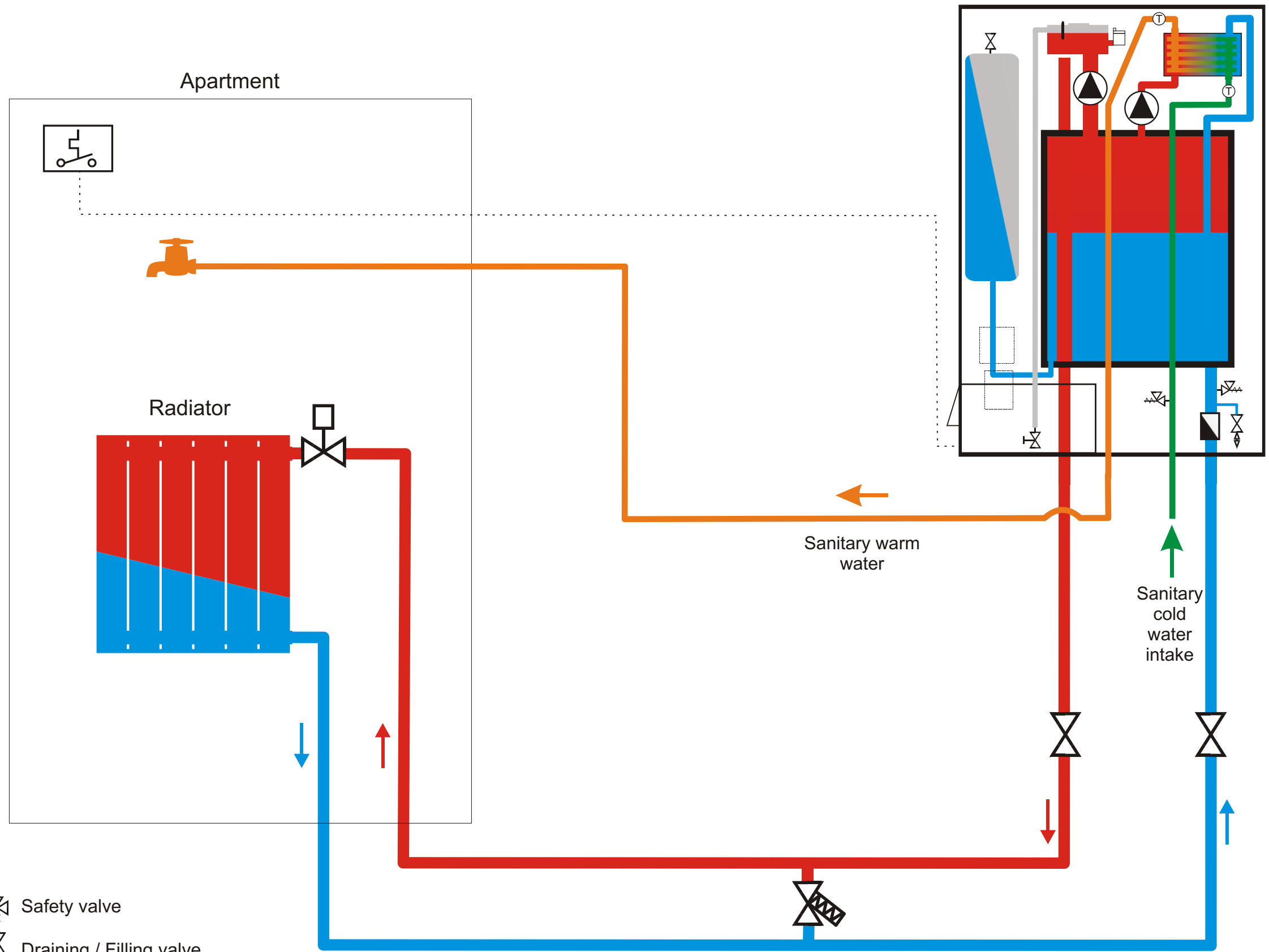



- Pump
- Valve
- Thermal valve
- Overflow valve
- Ambient thermostat
- Automatic vent slide
- Safety valve
- Draining / Filling valve
- Temperature sensor
- One way valve
- Air venting valve

### Remark:

This schema is for informational purposes only, not all details necessary for deployment are shown.  
**DO NOT USE THIS SCHEMA AS DEPLOYMENT PLAN.**



### Legend

-  Pump
-  Valve
-  Thermal valve
-  Overflow valve
-  Ambient thermostat
-  Automatic vent slide
-  Safety valve
-  Draining / Filling valve
-  Temperature sensor
-  One way valve
-  Air venting valve

### Remark:

This schema is for informational purposes only, not all details necessary for deployment are shown.  
**DO NOT USE THIS SCHEMA AS DEPLOYMENT PLAN.**